

Owner's Manual & Safety Instructions

Save This Manual Keep this manual for the safety warnings and precautions, assembly, operating, inspection, maintenance and cleaning procedures. Write the product's serial number in the back of the manual near the assembly diagram (or month and year of purchase if product has no number). Keep this manual and the receipt in a safe and dry place for future reference.

CHICAGO ELECTRIC **WELDING**

MIG 170 WIRE FEED WELDER



Visit our website at: <http://www.harborfreight.com>
Email our technical support at: tech@harborfreight.com

ITEM 68885

When unpacking, make sure that the product is intact and undamaged. If any parts are missing or broken, please call 1-800-444-3353 as soon as possible.

Copyright© 2011 by Harbor Freight Tools®. All rights reserved. No portion of this manual or any artwork contained herein may be reproduced in any shape or form without the express written consent of Harbor Freight Tools. Diagrams within this manual may not be drawn proportionally. Due to continuing improvements, actual product may differ slightly from the product described herein. Tools required for assembly and service may not be included.

⚠ WARNING

**Read this material before using this product.
Failure to do so can result in serious injury.
SAVE THIS MANUAL.**

Table of Contents

Safety	2	Welding Tips	23
Setup	7	Maintenance	27
Specifications	7	Parts List and Diagrams	30
Basic Welding	15	Warranty	32

SAFETY





SETUP

BASIC WELDING

WELDING TIPS

MAINTENANCE

WARNING SYMBOLS AND DEFINITIONS

	This is the safety alert symbol. It is used to alert you to potential personal injury hazards. Obey all safety messages that follow this symbol to avoid possible injury or death.
	Indicates a hazardous situation which, if not avoided, will result in death or serious injury.
	Indicates a hazardous situation which, if not avoided, could result in death or serious injury.
	Indicates a hazardous situation which, if not avoided, could result in minor or moderate injury.
	Addresses practices not related to personal injury.

IMPORTANT SAFETY INFORMATION

WARNING

Read all safety warnings and instructions.

Failure to follow the warnings and instructions may result in electric shock, fire and/or serious injury.

Save all warnings and instructions for future reference.

General Safety

PROTECT yourself and others. Read and understand this information.

- Before use, read and understand manufacturer's instructions, Material Safety Data Sheets (MSDS's), employer's safety practices, and ANSI Z49.1.**
- Keep out of reach of children.**
Keep children and bystanders away while operating.
- Place the welder on a stable location before use.**
If it falls while plugged in, severe injury, electric shock, or fire may result.
- Do not overreach.**
Keep proper footing and balance at all times.
- Stay alert, watch what you are doing and use common sense when operating a welder. Do not use a welder while you are tired or under the influence of drugs, alcohol or medication.**
A moment of inattention while operating welders may result in serious personal injury.
- Avoid unintentional starting.** Make sure you are prepared to begin work before turning on the Welder.
- Never leave the Welder unattended while energized.** Turn power off if you have to leave.
- The warnings, precautions, and instructions discussed in this instruction manual cannot cover all possible conditions and situations that may occur.** It must be understood by the operator that common sense and caution are factors which cannot be built into this product, but must be supplied by the operator.
- This product, when used for welding and similar applications, contains or produces a chemical known to the State of California to cause cancer and birth defects (or other reproductive harm).**
(California Health & Safety Code § 25249.5, *et seq.*)
- Handling the cord on this product will expose you to lead, a chemical known to the State of California to cause cancer, and birth defects or other reproductive harm.**
Wash hands after handling.
(California Health & Safety Code § 25249.5, *et seq.*)

Fume and Gas Safety



FUMES AND GASES can be hazardous to your health.

- 1. Exposure to welding or cutting exhaust fumes can increase the risk of developing certain cancers, such as cancer of the larynx and lung cancer.**
Also, some diseases that may be linked to exposure to welding or cutting exhaust fumes are:
 - Early onset of Parkinson's Disease
 - Heart disease • Ulcers
 - Damage to the reproductive organs
 - Inflammation of the small intestine or stomach • Kidney damage
 - Respiratory diseases such as emphysema, bronchitis, or pneumonia
- 2. Do not use near degreasing or painting operations.**
- 3. Keep head out of fumes.**
Do not breathe exhaust fumes.
- 4. Use enough ventilation, exhaust at arc, or both, to keep fumes and gases from breathing zone and general area.** If engineering controls are not feasible, use an approved respirator.
- 5. Work in a confined area only if it is well-ventilated, or while wearing an air-supplied respirator.**
- 6. Have a recognized specialist in Industrial Hygiene or Environmental Services check the operation and air quality and make recommendations for the specific welding situation.**
Follow OSHA guidelines for Permissible Exposure Limits (PEL's) and the American Conference of Governmental Industrial Hygienists recommendations for Threshold Limit Values (TLV's) for fumes and gases.

Arc Ray Safety



ARC RAYS can injure eyes and burn skin.

- 1. Wear ANSI-approved welding eye protection featuring at least a number 10 shade lens rating.**
- 2. Wear leather leggings, fire resistant shoes or boots during use.** Do not wear pants with cuffs, shirts with open pockets, or any clothing that can catch and hold molten metal or sparks.
- 3. Keep clothing free of grease, oil, solvents, or any flammable substances.**
Wear dry, insulating gloves and protective clothing.
- 4. Wear an approved head covering to protect the head and neck.** Use aprons, cape, sleeves, shoulder covers, and bibs designed and approved for welding and cutting procedures.
- 5. When welding/cutting overhead or in confined spaces, wear flame resistant ear plugs or ear muffs to keep sparks out of ears.**

Electrical Safety



ELECTRIC SHOCK can KILL.

1. **Turn off, disconnect power, and discharge electrode to ground before setting down torch/electrode holder and before service.**
2. **Do not touch energized electrical parts.** Wear dry, insulating gloves. Do not touch electrode holder, electrode, welding torch, or welding wire with bare hand. Do not wear wet or damaged gloves.
3. **Connect to grounded, GFCI-protected power supply only.**
4. **Do not use near water or damp objects.**
5. **People with pacemakers should consult their physician(s) before use.** Electromagnetic fields in close proximity to heart pacemaker could cause pacemaker interference or pacemaker failure.
6. **Do not expose welders to rain or wet conditions.** Water entering a welder will increase the risk of electric shock.
7. **Do not abuse the cord. Never use the cord for carrying, pulling or unplugging the welder. Keep cord away from heat, oil, sharp edges or moving parts. Damaged or entangled cords increase the risk of electric shock.**
8. **Do not use outdoors.**
9. **Insulate yourself from the workpiece and ground.** Use nonflammable, dry insulating material if possible, or use dry rubber mats, dry wood or plywood, or other dry insulating material large enough to cover your full area of contact with the work or ground.

SAFETY

SETUP

BASIC WELDING

WELDING TIPS

MAINTENANCE

Fire Safety



ARC AND HOT SLAG can cause fire.

1. **Clear away or protect flammable objects.** Remove or make safe all combustible materials for a radius of 35 feet (10 meters) around the work area. Use a fire resistant material to cover or block all open doorways, windows, cracks, and other openings.
2. **Keep ABC-type fire extinguisher near work area and know how to use it.**
3. **Maintain a safe working environment.** Keep the work area well lit. Make sure there is adequate surrounding workspace. Keep the work area free of obstructions, grease, oil, trash, and other debris.
4. **Do not operate welders in atmospheres containing dangerously reactive or flammable liquids, gases, vapors, or dust.** Provide adequate ventilation in work areas to prevent accumulation of such substances. *Welders create sparks which may ignite flammable substances or make reactive fumes toxic.*
5. **If working on a metal wall, ceiling, etc., prevent ignition of combustibles on the other side by moving the combustibles to a safe location.** If relocation of combustibles is not possible, designate someone to serve as a fire watch, equipped with a fire extinguisher, during the cutting process and for at least one half hour after the cutting is completed.
6. **Do not weld or cut on materials having a combustible coating or combustible internal structure, as in walls or ceilings, without an approved method for eliminating the hazard.**
7. **Do not dispose of hot slag in containers holding combustible materials.**
8. **After welding, make a thorough examination for evidence of fire.** Be aware that easily visible smoke or flame may not be present for some time after the fire has started.
9. **Do not apply heat to a container that has held an unknown substance or a combustible material whose contents, when heated, can produce flammable or explosive vapors.** Clean and purge containers before applying heat. Vent closed containers, including castings, before preheating, welding, or cutting.

Welder use and care

1. **Do not use the welder if the switch does not turn it on and off.** *Any welder that cannot be controlled with the switch is dangerous and must be repaired.*
2. **Disconnect the plug from the power source before making any adjustments, changing accessories, or storing welders.** *Such preventive safety measures reduce the risk of starting the welder accidentally.*
3. **Prevent unintentional starting.** **Ensure the switch is in the off-position before connecting to power source or moving the welder.** *Carrying or energizing welders that have the switch on invites accidents.*
4. **Store idle welders out of the reach of children and do not allow persons unfamiliar with the welder or these instructions to operate the welder.** Welders are dangerous in the hands of untrained users.
5. **Use the welder and accessories in accordance with these instructions, taking into account the working conditions and the work to be performed.** *Use of the welder for operations different from those intended could result in a hazardous situation.*

Maintenance

1. **Maintain welders. Check for misalignment or binding of moving parts, breakage of parts and any other condition that may affect the welder's operation. If damaged, have the welder repaired before use.** *Many accidents are caused by poorly maintained welders.*
2. **Have your welder serviced by a qualified repair person using only identical replacement parts.** *This will ensure that the safety of the welder is maintained.*
3. **Maintain labels and nameplates on the Welder.** These carry important information. If unreadable or missing, contact Harbor Freight Tools for a replacement.
4. **Unplug before maintenance.** Unplug the Welder from its electrical outlet before any inspection, maintenance, or cleaning procedures.

Gas Shielded Welding - Cylinder safety

Cylinders can explode when damaged.



1. **Never weld on a pressurized or a closed cylinder.**
2. **Never allow an electrode holder, electrode, welding torch, or welding wire to touch the cylinder.**
3. **Keep cylinders away from any electrical circuits, including welding circuits.**
4. **Keep protective cap in place over the valve except when the cylinder is in use.**
5. **Use only correct gas shielding equipment designed specifically for the type of welding you will do.** Maintain this equipment properly.
6. **Protect gas cylinders from heat, being struck, physical damage, slag, flames, sparks, and arcs.**
7. **Always use proper procedures to move cylinders.**



SAVE THESE INSTRUCTIONS.

Grounding

⚠ WARNING



TO PREVENT ELECTRIC SHOCK AND DEATH FROM INCORRECT GROUNDING WIRE CONNECTION:

Check with a qualified electrician if you are in doubt as to whether the outlet is properly grounded. Have a plug installed by a certified electrician.

Do not use the welder if the power cord or plug is damaged. If damaged, have it repaired by a service facility before use. If the plug will not fit the outlet, have a proper outlet installed by a qualified electrician, do not use adapter plugs.

1. The green wire inside the cord is connected to the grounding system in the welder. The green wire in the cord must be the only wire connected to the welder's grounding system and must never be attached to an electrically "live" terminal. Never leave the grounding wire disconnected or modify the Power Cord Plug in any way.
2. Make sure the tool is connected to an outlet having the same configuration as the plug. If the tool must be reconnected for use on a different type of electric circuit, the reconnection should be made by qualified service personnel; and after reconnection, the tool should comply with all local codes and ordinances.
3. A 250 V~ plug will need to be installed by a certified electrician before use.
4. The plug shown (NEMA 6-50p) is for use on a 50 A circuit. A different 250 V~ plug and outlet combination may be used, provided it is rated to handle the electrical requirements of the tool and is installed by a certified electrician.



**DO NOT USE
125 V~ PLUG.
NOTE SIZE
DIFFERENCE.**

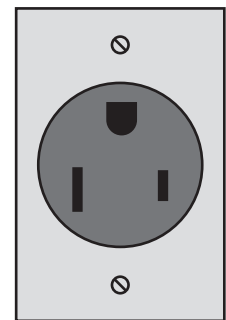
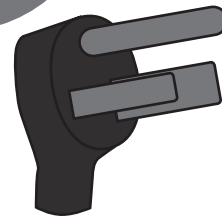

**250 V~ 3-Prong Plug (6-50p) and Outlet (6-50r)
(for up to 250 V~ and up to 50 A)**







Extension Cords

Do not use an extension cord on this welder.

Replacement Cords

1. A qualified electrician can install either of the following UL-listed, 3 wire cords as a replacement cord for this welder:
12 AWG up to 6 feet long,
10 AWG up to 75 feet long, or
6 AWG up to 175 feet long.
2. **Do not install a thinner or longer cord on this welder.**
3. **Do not patch cords of any length together for this item, patches may allow moisture to penetrate the insulation, resulting in electric shock.**

Symbology

	Wire Feed (Speed)
	Workpiece Ground Cable
	Torch Cable
	Overheat Shutdown Indicator
	Cooling Fan
	Housing Ground Point

V~	Volts Alternating Current
A	Amperes
OCV	Open Circuit Voltage
KVA	Kilovolt Amperes (Volts / 1000 * Amperes)
IPM	Inches Per Minute
AWG	American Wire Gauge

Specifications

Power Input	240 V~, 20 A
Welding Output	DCEN/DCEP 30-170 A
Capacity	22 gauge (0.031") to 1/4" (0.25") mild or stainless steel Not for welding aluminum
Rated Duty Cycle	20% at 110A (See explanation on page 16)
Open Circuit Voltage	38
KVA	4.8
Wire Speed	30 – 650 IPM
Cable Sizes	Ground: 6', 7 AWG Torch: 6', 7 AWG Power: 3-wire, 6' 5", 12 AWG 6-50P NEMA plug type
Wire Spool Capacity	up to 10 lb. spool (one 1 lb. spool of flux-core wire included)
Accessories	Spare Welder Tips (one each for .023" and .030"– .035" wire) Welding Face Shield Combination Wire Brush / Chipping Hammer

Setup



Read the **ENTIRE IMPORTANT SAFETY INFORMATION** section at the beginning of this manual including all text under subheadings therein before set up or use of this product.



TO PREVENT SERIOUS INJURY FROM ACCIDENTAL OPERATION:
Turn the Power Switch off and unplug the welder before assembly.

Note: Remove the protective foam and cardboard from the welder before setup.

Face Shield Assembly

1. Attach the handle to the Face Shield by lining up the two rectangular tabs on the handle with the corresponding holes in the face shield and
 - A. press the tabs through the holes and then
 - B. slide the tabs forward from the back, locking the round tab in place.

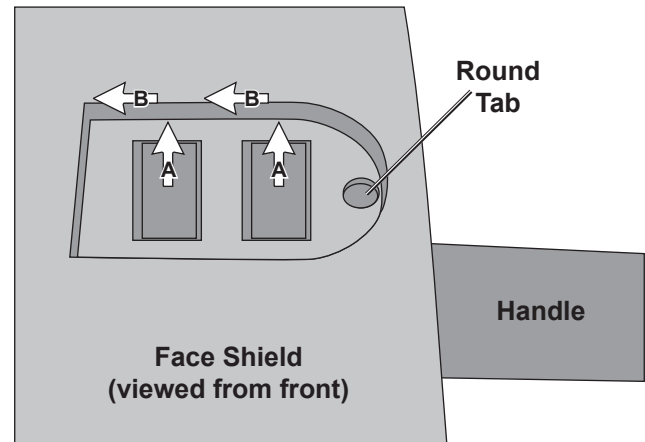

2. Wear heavy-duty work gloves, the edges of the filter lens may be sharp. Remove any protective film from both sides of the filter lens. Slide the filter lens into the helmet behind the holding tabs. Make sure that the filter lens fits securely and that light cannot leak around its edges.

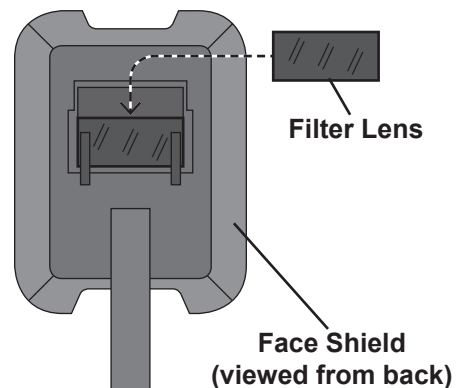

Plug Attachment

1. A 250 V~ plug will need to be installed by a **certified electrician** before use.
2. The plug shown is for use on a 50 A circuit. A different 250 V~ plug and outlet combination may be used, provided it is rated to handle the electrical requirements of the tool and is installed by a certified electrician.

Note: Although 125 V~ plugs may look similar, the required plug is much larger, see illustration.



**DO NOT USE
125 V~ PLUG.
NOTE SIZE
DIFFERENCE.**

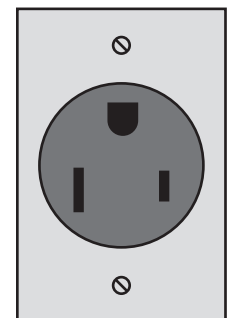
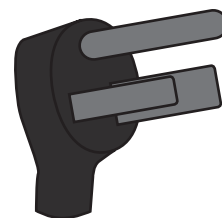

**250 V~ 3-Prong Plug (6-50p) and Outlet (6-50r)
(for up to 250 V~ and up to 50 A)**

Wire Spool Installation

1. Turn the welder OFF and unplug it before proceeding.

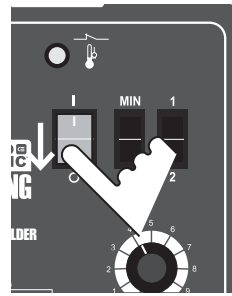

2. Pull up on the door latch, then open the Door.

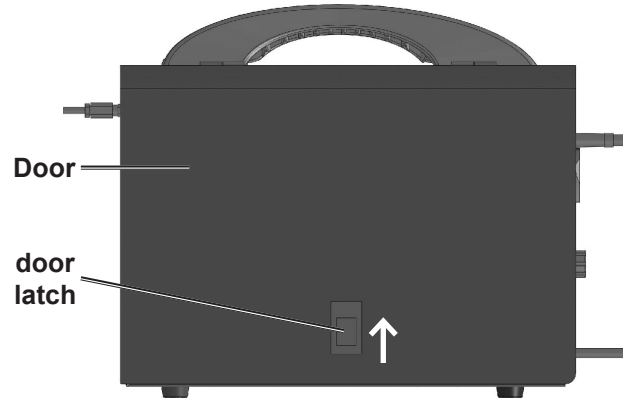

3. Remove the Spool Knob, Spool Spring, and upper Spool Plate. If replacing a Spool, remove the old Spool and all remaining wire from the liners.

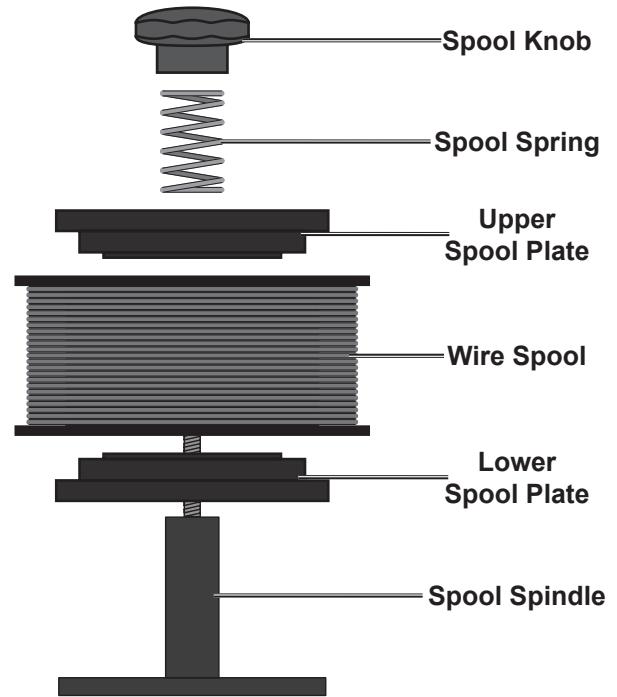

4. Place the new Wire Spool over the Spool Spindle and on top of the lower Spool Plate as illustrated. **To prevent wire feed problems, set the Spool so that it will unwind clockwise.**

5. Secure Spool in place with the upper Spool Plate (narrower end against the Spool), then the Spool Spring and Spool Knob.

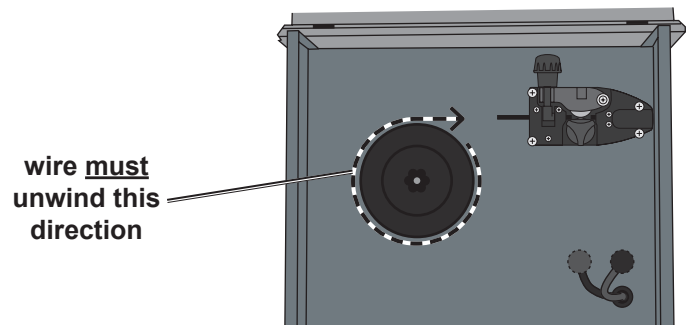

SAFETY

SETUP

BASIC WELDING

WELDING TIPS

MAINTENANCE

6a. **Flux Core (Gas-less) Wire Setup:**

Remove the two Knobs securing the cables. Connect the Black Ground Cable to the rear, red, positive Terminal using the Knob. Connect the Red Torch Cable to the front, black, negative Terminal using the other Knob. **This is the initial setup**, called Direct Current Electrode Negative (DCEN).

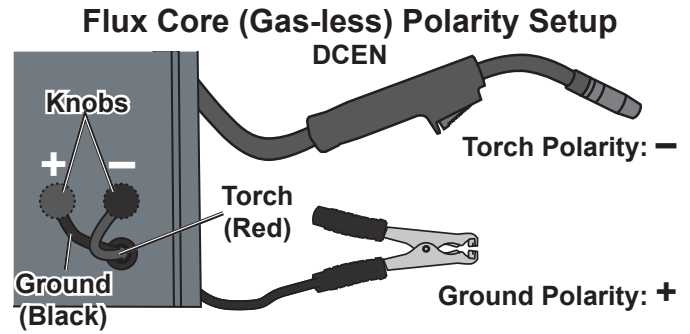
6b. **Solid Core (Gas Shielded) Wire Setup:**

- a. Remove the two Knobs securing the cables. Connect the Black Ground Cable to the front, black, negative Terminal using the Knob. Connect the Red Torch Cable to the rear, red, positive Terminal using the other Knob. This is called Direct Current Electrode Positive (DCEP).

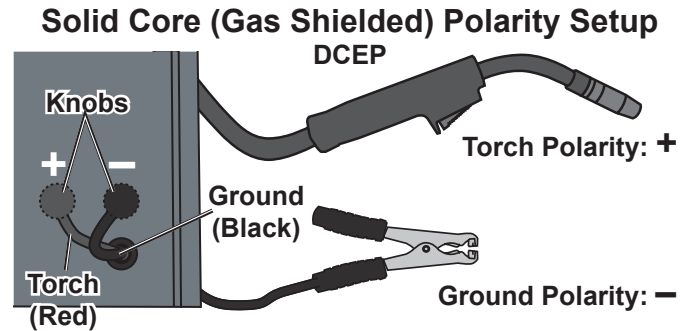

- b. Determine which type of shielding gas would be appropriate for the welding you will do - see chart on welder.

- c. With assistance, set the cylinder (not included) onto a shelf or cart near the welder and secure the cylinder in place with two straps (not included).

- d. Remove the protective cap from the cylinder (if present). Stand to the side of the valve opening, and open the valve briefly to blow dust and dirt from the valve opening. Close the cylinder valve.

- e. Obtain an appropriate Regulator/Flowmeter (not included) and close its valve completely. Thread its inlet connector onto the cylinder and wrench tighten.

- f. Attach the Gas Hose securely to the outlet of the Regulator/Flowmeter using a hose clamp (sold separately).

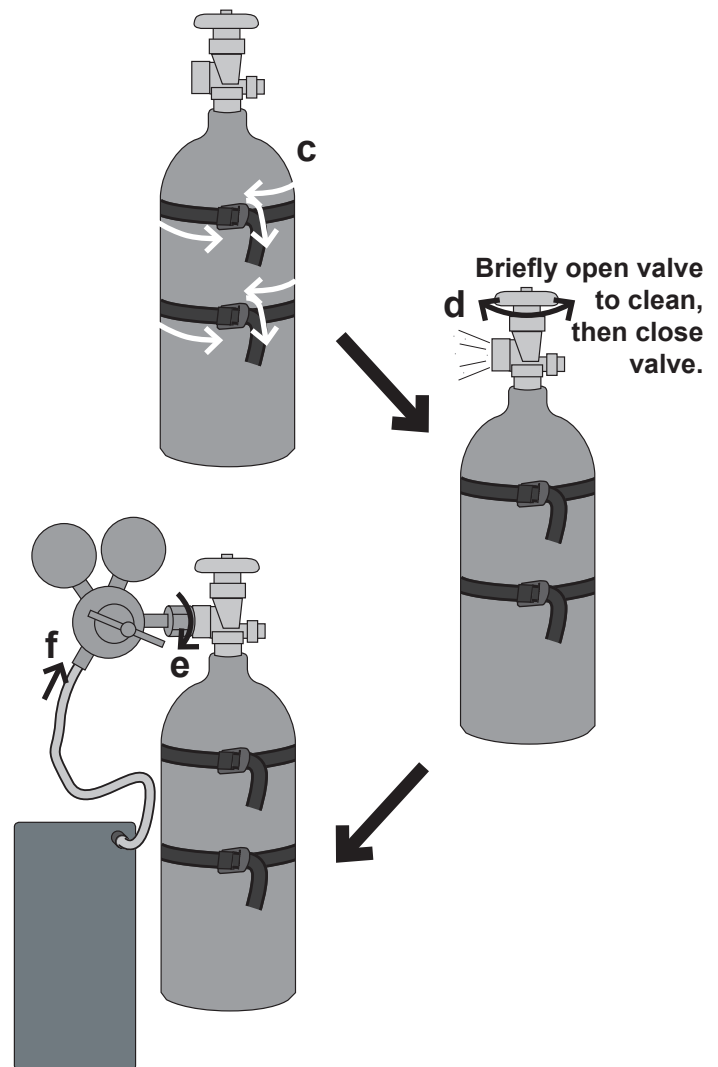

Note: If the threads do not match, then the Regulator/Flowmeter is likely for a different type of cylinder/gas.

7. Turn the Feed Tensioner knob counterclockwise to loosen it enough to pull it down to remove tension. (Do not loosen the Tensioner knob too much, or the Tensioner will come apart.) Then, swing the Feed Swing Arm up.

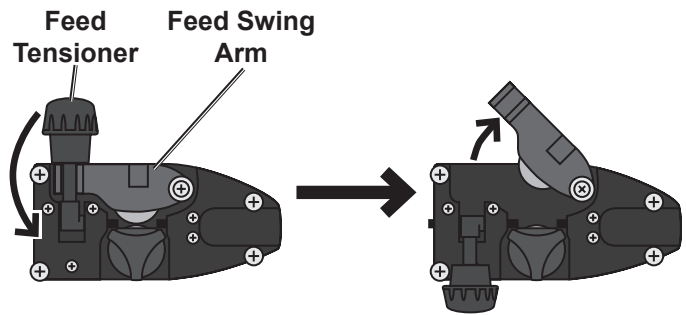

8. **Feed Roller Instructions:**
Check that the Feed Roller is turned to properly match the wire size marked on the Wire Spool:

- A. Twist the Feed Roller Knob about 1/3 of a turn counterclockwise \curvearrowleft until it stops.

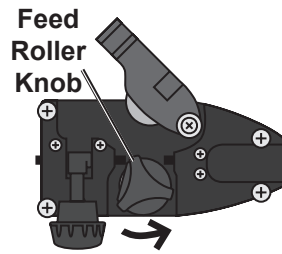

- B. Pull the Feed Roller Knob straight off to expose the Feed Roller.

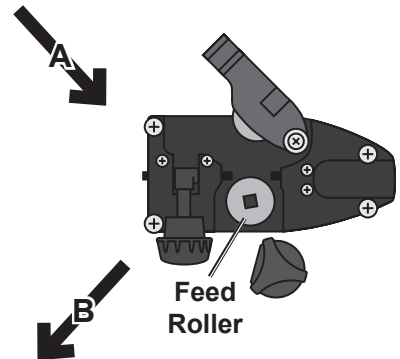

- C. Flip the Feed Roller as needed and confirm that the number facing you is the same as the wire diameter on the Spool. (**0.8mm = .030" & 0.6mm = .023"**)

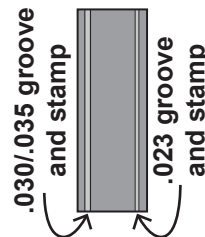

- D. Place the Feed Roller Knob back into place in the same orientation it was removed in, and twist it about 1/3 of a turn clockwise to secure it.

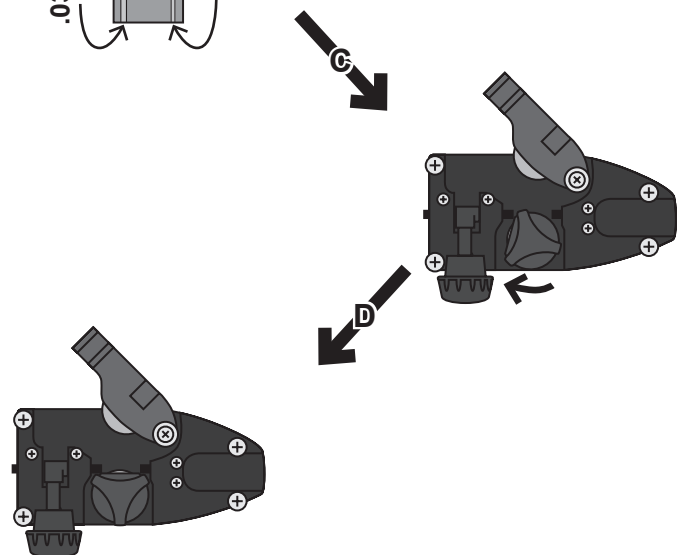

SAFETY

SETUP

BASIC WELDING

WELDING TIPS

MAINTENANCE

IMPORTANT:

Securely hold onto the end of the welding wire and keep tension on it during the following steps.

If this is not done, the welding wire will unravel and create a tangled “bird’s nest”, wasting wire.

9. Cut off all bent and crimped wire. The cut end must have no burrs or sharp edges; cut again if needed.
10. Keep tension on the wire and guide at least 12 inches of wire into the Wire Liners.

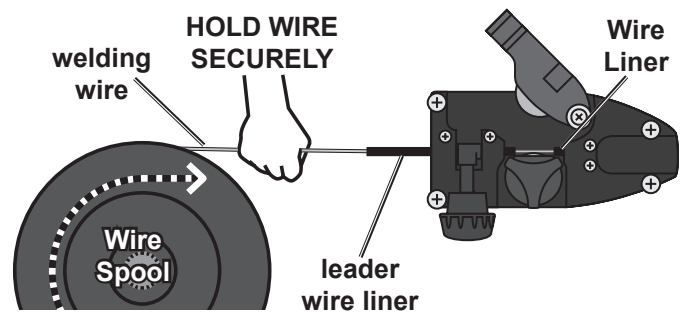

11. Swing the wire feed swing arm down, and swing the feed tensioner up to latch it across the tip of the arm. Make sure the Welding Wire is resting in the bottom groove of the Feed Roller, then turn the feed tensioner knob clockwise a couple of turns. After the wire is held by the tensioner, you may release it.

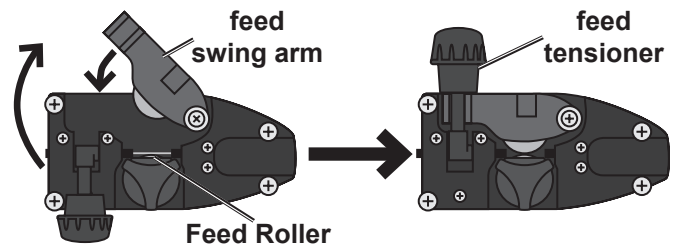

12. Pull the Nozzle to remove it.
13. Using the third oval hole on the Multi-wrench, turn the Contact Tip counterclockwise and remove.

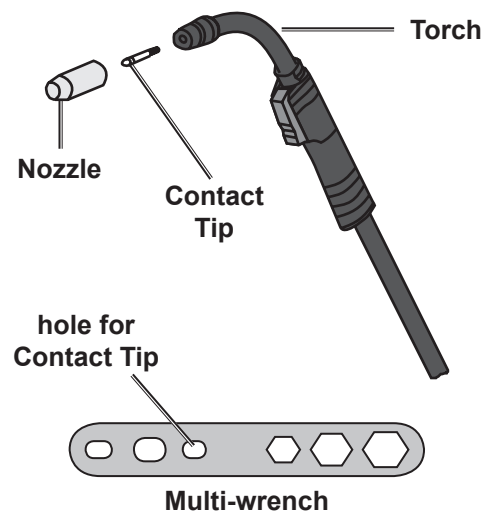

14. Lay the Torch Cable out in a straight line so that the wire moves through it easily. Leave the cover open, so that the feed mechanism can be observed.



⚠️ WARNING

The following steps require applying power to the welder with the cover open.

To prevent serious injury from fire or electric shock:

1. Do not touch anything (especially not the Ground Clamp) with the Torch or welding wire, or an arc may be ignited.
2. Do not touch internal welder components while it is plugged in.

SAFETY

15. Do not touch the Torch's Trigger. Plug the Power Cord into its electrical outlet and turn the welder ON.

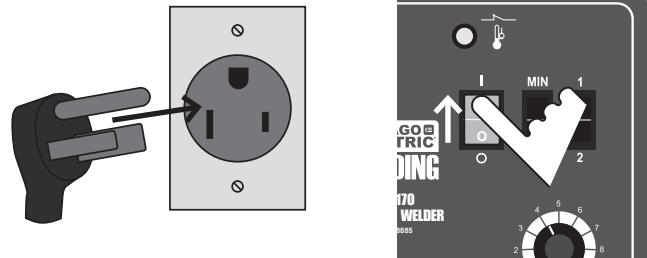

SETUP

16. Point the Torch away from all objects and press the trigger until the wire feeds through two inches. **The wire liner may come out with the welding wire, this is normal, just push the wire liner back into the Torch.** If the wire does not feed properly and the Spool is stationary, turn the welder OFF, unplug it, and slightly tighten the feed tensioner clockwise before retrying.

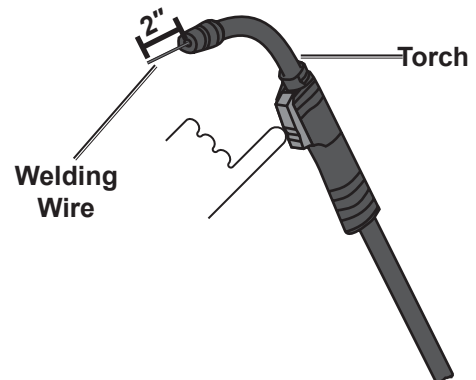

BASIC WELDING

IMPORTANT

Stainless steel wire is less flexible than other welding wire. Therefore, it is more difficult to feed through the liner and torch. It is especially important to keep the torch cable straight while feeding stainless steel wire.

WELDING TIPS

MAINTENANCE

17. To check the wire's drive tension, feed the wire against a piece of wood from 2 to 3 inches away. If the wire stops instead of bending, turn the welder OFF, unplug it, slightly tighten the feed tensioner clockwise, and try again. If the wire bends from the feed pressure, then the tension is set properly.

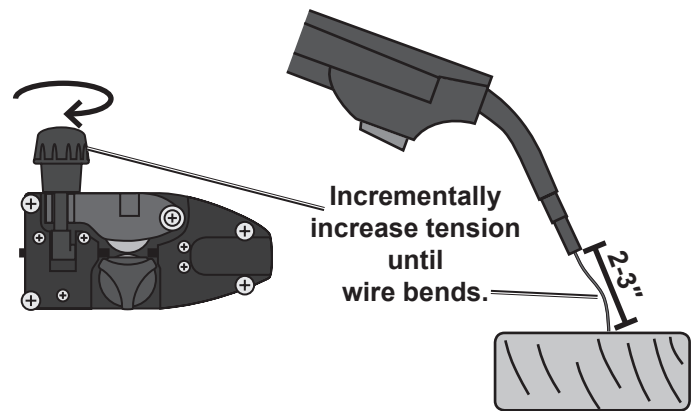

18. TURN THE WELDER OFF.

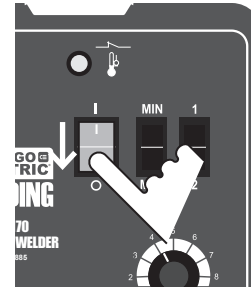

19. Select a Contact Tip that is compatible with the welding wire used. The pre-installed Tip is .035". Slide the Contact Tip over the wire and thread it clockwise into the Torch. Tighten the Contact Tip using the Multi-wrench.
20. Replace the Nozzle and cut the wire off at $\frac{1}{2}$ " from tip ($\frac{1}{2}$ " stickout).

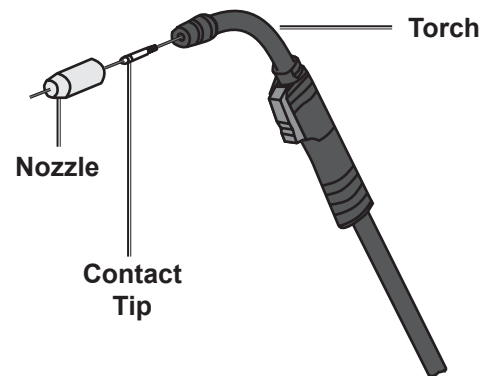

21. Swing the Door closed, lift the door latch, press on the bottom center of the Door until the door is completely closed, and release the latch.

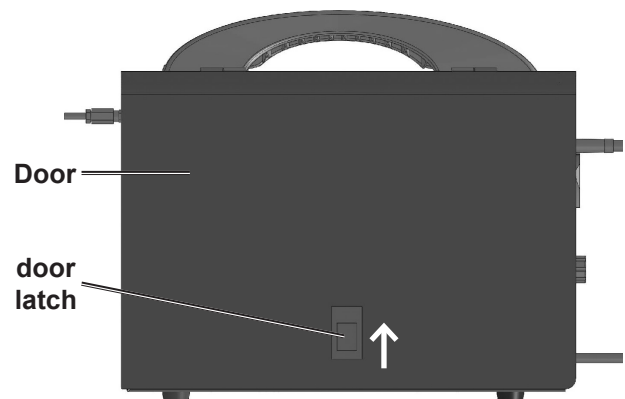

Basic Welding



Read the **ENTIRE IMPORTANT SAFETY INFORMATION** section at the beginning of this manual including all text under subheadings therein before welding.

WARNING

TO PREVENT SERIOUS INJURY:

Protective gear must be worn when using the Welder; minimum shade number 10 full face shield (or welding mask), ear protection, welding gloves, sleeves and apron, NIOSH-approved respirator, and fire resistant work clothes without pockets should be worn when welding.

Light from the arc can cause permanent damage to the eyes and skin. Do not breathe arc fumes.

Flux-core wire welding is used to weld sheet metal and low carbon steel without shielding gas. MIG welding uses solid-core wire and shielding gas, and is used to weld sheet metal and low carbon steel. MIG welding can also be used to weld thinner workpieces than flux-core welding can.

Good welding takes a degree of skill and experience. Practice a few sample welds on scrap before welding your first project. Additional practice periods are recommended whenever you weld:

- a different thickness of material
- a different type of material
- a different type of connection
- using a different technique (MIG vs. flux)

Make practice welds on pieces of scrap to practice technique before welding anything of value.



Practice your welding technique on scrap pieces before welding anything of value.

CHICAGO ELECTRIC WELDING

Control Panel Layout

SAFETY

SETUP

BASIC WELDING

WELDING TIPS

MAINTENANCE

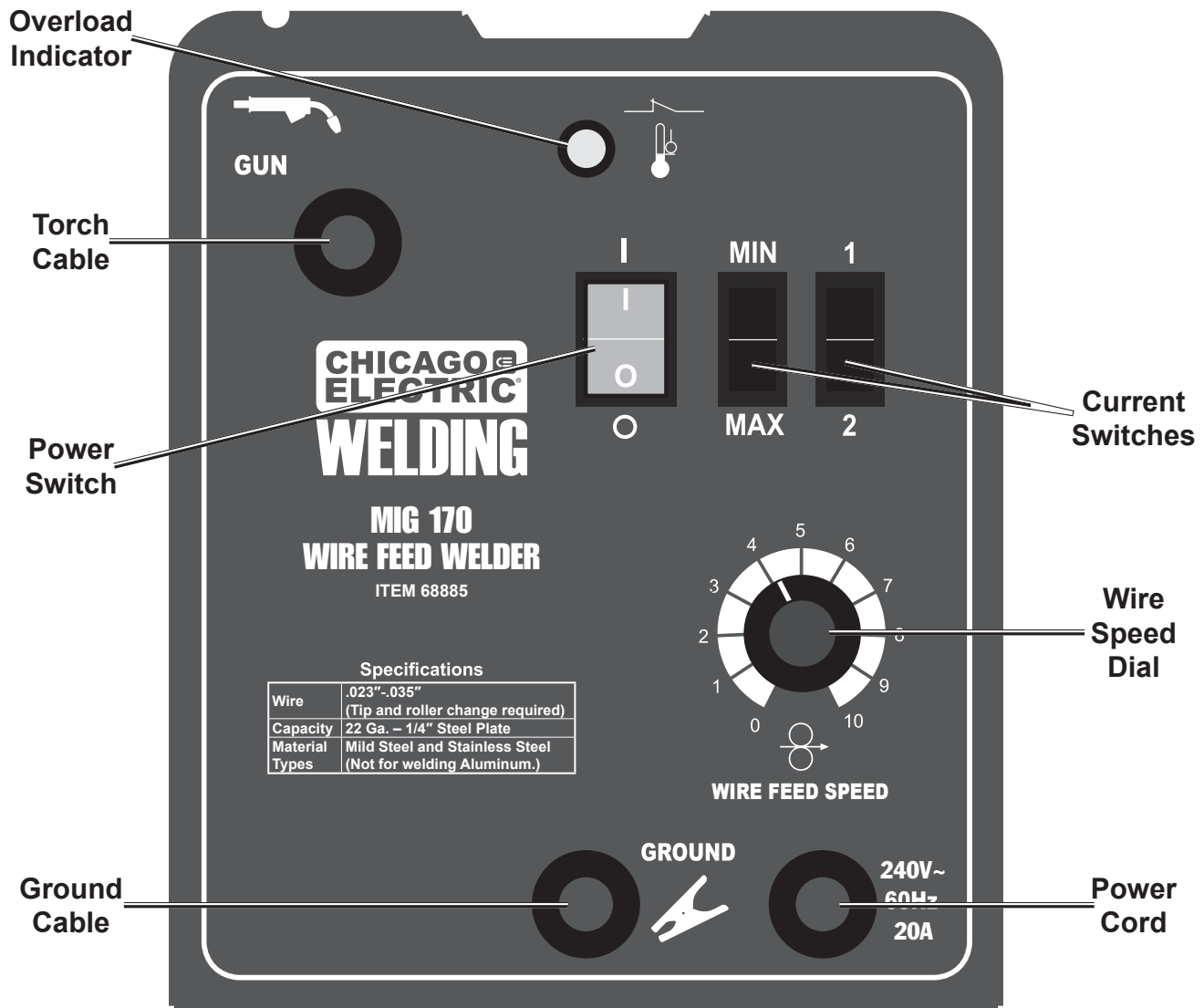

Overload Indicator:

This lights up if duty cycle work period is exceeded, resulting in overheating the welder. Rest the Torch on an electrically non-conductive, heat-resistant surface, such as a concrete slab, well clear of the ground clamp while allowing the welder to cool with the Power Switch on, so the Fan can help cool the welder. Once the welder cools enough to be used again, use shorter welding periods and longer rest periods to prevent needless wear.

Power Switch:

This turns on power to the welding Torch and internal cooling fan. The welding Torch is energized whenever the Power Switch is on.

Current Switches:

These control the output amperage of the welder. Adjust them according to the weld settings chart to achieve a good weld.

Wire Speed Dial:

This controls the speed that the welding wire feeds out of the welding Torch and adapts output amperage somewhat. Adjust this according to the weld settings chart to achieve a good weld.

Power Cord:

Plug the Power Cord into a properly grounded 240 V~ (at least 30 amp rating) outlet with delayed action type circuit breaker or fuses.

Torch Cable:

The welding Torch connects here. The wire and welding current feeds to the weld through here.

Ground Cable:

This connects to the base metal to provide a good connection for the current to travel back to the welder.

Duty Cycle (Duration of Use)

Avoid damage to the Welder by not welding for more than the prescribed duty cycle time.

The Duty Cycle defines the number of minutes, within a 10 minute period, during which a given welder can produce a particular welding current without overheating. **For example, this Welder with a 20% duty cycle at rated output (110A) must be allowed to rest for at least 8 minutes after every 2 minutes of continuous welding.** Failure to carefully observe any duty cycle limitations can easily over-stress a welder's power generation system contributing to premature welder failure.

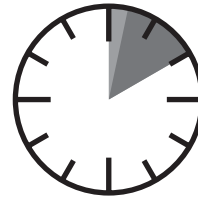

**20% Rated Duty Cycle at 110A output
2 minutes welding followed by
at least 8 minutes
of rest**

This welder has an internal thermal protection system to help prevent this sort of over-stress. When the unit overheats, it automatically shuts down and the Overload Indicator lights, then the welder automatically returns to service after cooling off. Rest the Torch on an electrically non-conductive, heat-proof surface, such as a concrete slab, well clear of the ground clamp while allowing the welder to cool with the Power Switch on, so that the internal Fan will help cool the welder. When the welder can be used again, use shorter welding periods and longer rest periods to prevent needless wear.

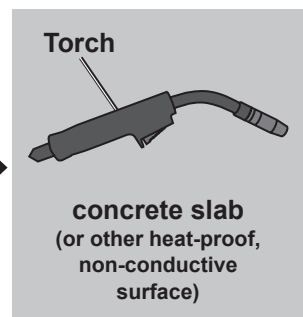

Note: The following charts are only intended to show general guidelines for different wire sizes and for different thicknesses of material. The settings should only be used at the beginning of a weld and must be adjusted after stopping and carefully inspecting the weld. Proper welding takes experience.

Flux Weld Settings

SAFETY

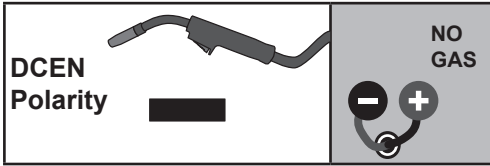

Metal Thickness

Material Being Welded	Wire Type	Shielding Gas	Wire Diameter	Suggested Settings	22 Ga .030" 0.8mm	18 Ga .048" 1.2mm	16 Ga .060" 1.5mm	14 Ga .075" 2.0mm	1/8" 3.2mm	3/16" 4.8mm	1/4" 6.4mm
Mild Steel	Flux-core (E71T-GS)	NO GAS Required	.030"	Current	MIN 1	MIN 2	MIN 2	MAX 1	X	X	X
				Wire Feed	2	3	4	5			
			.035"	Current	X	MIN 1	MIN 2	MAX 1	MAX 1	MAX 2	
				Wire Feed		2	3	4	6	7	

SETUP

BASIC WELDING

MIG Weld Settings

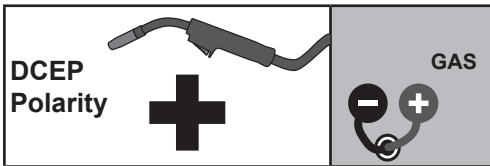

Metal Thickness

Material Being Welded	Wire Type	Wire Diameter	Shielding Gas	Suggested Settings	22 Ga .030" 0.8mm	18 Ga .048" 1.2mm	16 Ga .060" 1.5mm	14 Ga .075" 2.0mm	1/8" 3.2mm	3/16" 4.8mm	1/4" 6.4mm
Mild Steel	Solid (E70S-6)	.023"	75% CO ₂ +25% Argon 6-8L / MIN	Current	MIN 1	MIN 2	X	X	X	X	X
				Wire Feed	5	6					
		.030"	75% CO ₂ +25% Argon 8-10L / MIN	Current	MIN 1	MIN 2	MIN 2	MAX 1	MAX 1	X	X
				Wire Feed	4	5	6	7	8.5		
		.035"	75% CO ₂ +25% Argon 8-10L / MIN	Current	X	MIN 2	MIN 2	MAX 1	MAX 1	MAX 2	MAX 2
				Wire Feed		2	2.5	3	5	8	10

WELDING TIPS

MAINTENANCE

Setting Up The Weld

1. **Make practice welds on pieces of scrap the same thickness as your intended workpiece to practice technique before welding anything of value.** Clean the weld surfaces thoroughly with a wire brush or angle grinder; there must be no rust, paint, oil, or other materials on the weld surfaces, only bare metal.
2. Use clamps (not included) to hold the workpieces in position so that you can concentrate on proper welding technique. The distance (if any) between the two workpieces must be controlled properly to allow the weld to hold both sides securely while allowing the weld to penetrate fully into the joint. The edges of thicker workpieces may need to be chamfered (or beveled) to allow proper weld penetration.

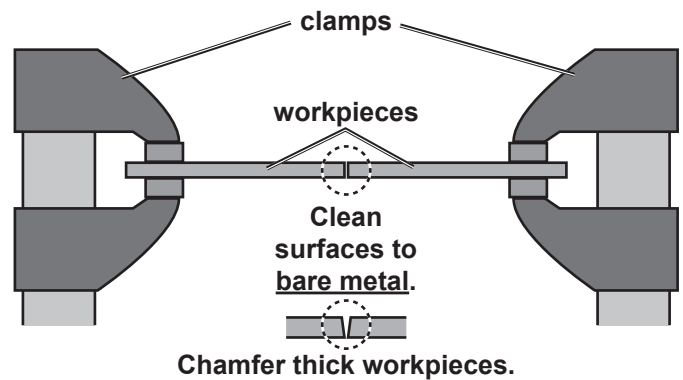

3. Clamp Ground Cable to bare metal on the workpiece near the weld area, or to metal work bench where the workpiece is clamped.

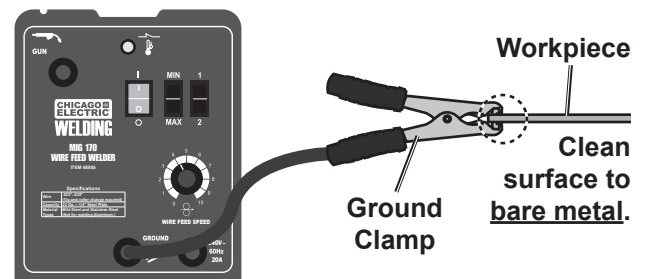

4. Set the Wire Speed Dial and the Current Switches to the desired settings. Refer to the chart on the welder or the chart on the previous page.
DO NOT SWITCH THE CURRENT WHILE WELDING.

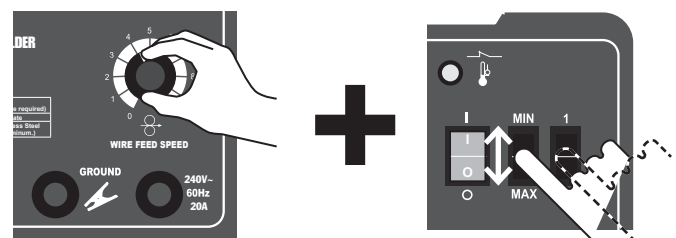

SAFETY

SETUP

BASIC WELDING

WELDING TIPS

MAINTENANCE

DANGER! TO PREVENT DEATH FROM ASPHYXIATION:

Do not open gas without proper ventilation. Fix gas leaks immediately.

Shielding gas can displace air and cause rapid loss of consciousness and death.

Shielding gas without carbon dioxide can be even more hazardous, because asphyxiation can start without feeling shortness of breath.



5. **Gas shielded, solid-core wire only:**
Open gas tank valve and adjust regulator/flowmeter to flow rate indicated on chart.

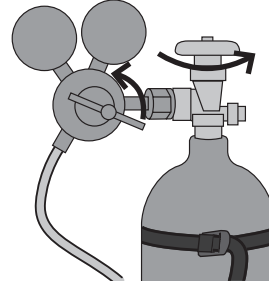

6. Flip the Power Switch to the OFF position, then plug the Welder into a dedicated, 240 V~ receptacle that matches the plug.
The circuit must be equipped with delayed action type circuit breaker or fuses.

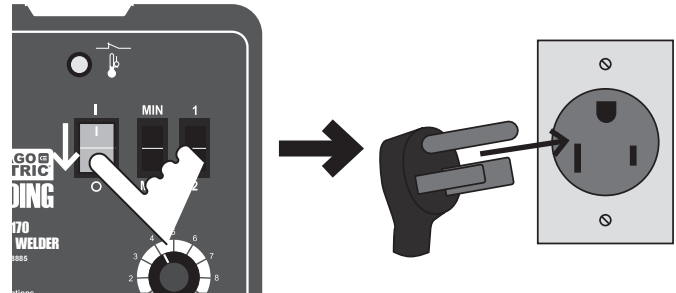

7. Hold the Torch, without touching the Trigger, with the wire and tip clearly out of the way of any grounded objects.
Then, turn the Power Switch ON.

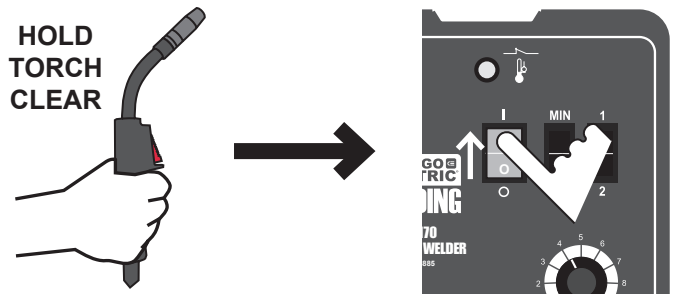

Basic Welding Technique

1. Press (and hold) Trigger and contact area to be welded with electrode wire to ignite arc.
2. For a narrow weld, you can usually draw the wire in a steady straight line, this is called a **stringer bead**.

For a wider weld, draw the wire back and forth across the joint, this is called a **weave bead** and takes practice to perform properly.

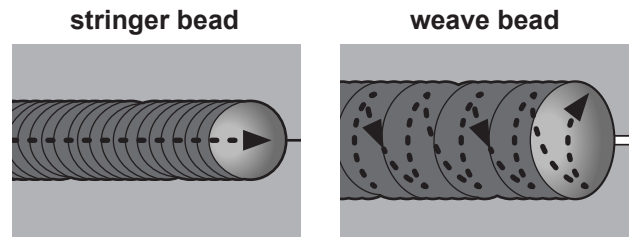

3. Hold Torch in one hand and the face shield in the other. If a hands-free welding shield (not included, see #6, page 4 for guidelines) is used, then both hands can be used to control Torch.
4. Direct the welding wire straight into the joint. This gives an angle of 90° (straight up and down) for butt (end to end) welds, and an angle of 45° for fillet (T-shaped) welds.

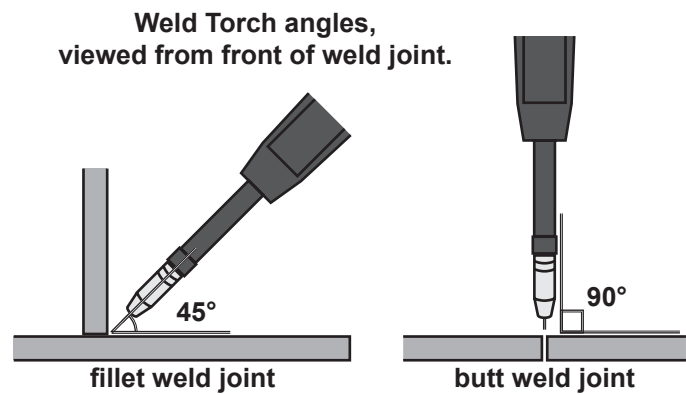

5. The end of torch should be tilted so that wire is angled anywhere in-between straight on and 15° in the direction you are welding. The amount of tilt is called the **drag angle**.
6. The welding wire should extend no more than 1/2" past the tip. This distance is called **stickout** or **CTWD** - Contact Tip to Work Distance.

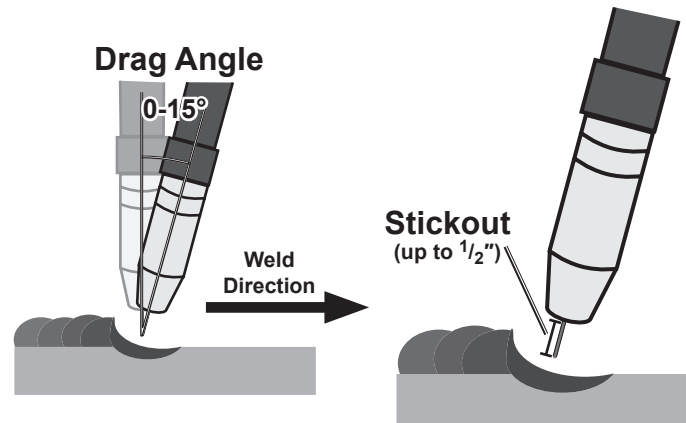

SAFETY

SETUP

BASIC WELDING

WELDING TIPS

MAINTENANCE

Note: If Welder is used too long, the amber Overload Indicator will light and the Welder Torch will shut off until the welder cools. If this happens, rest the Torch on an electrically non-conductive, heat-resistant surface, such as a concrete slab, well clear of the ground clamp. Wait about 8-10 minutes with the Power Switch ON for the welder to cool. When the welder can be used again, use shorter welding periods and longer rest periods to help prevent needless wear.

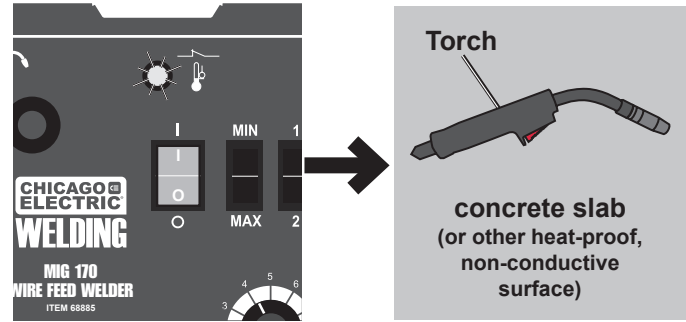

7. **After welding the test weld on a piece of scrap for a few seconds**, stop, and check your progress. Clean, then compare your weld's appearance with the diagrams and descriptions in the **Welding Tips** section starting on the next page. After making any necessary adjustments, continue to weld **while carefully following the DUTY CYCLE guidelines as explained on page 20.**

After practice welding for a few seconds, STOP and examine your weld using the guidelines starting on the next page.

FOLLOW DUTY CYCLE!



up to 2 minutes
welding at rated output

CAUTION! Weld will be hot, do not touch.

8. **When the weld is complete**, lift the Torch and welding wire clearly away from any grounded object, and turn the Power Switch off.

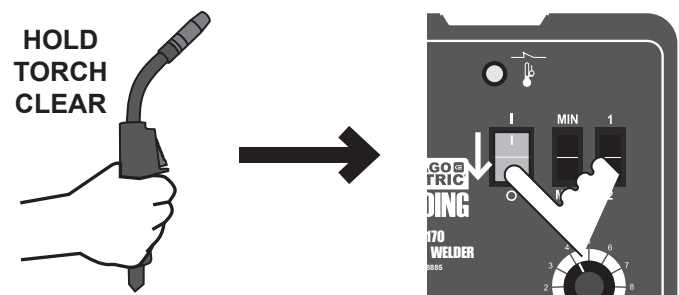

9. **Set the Torch down on a heat-proof, electrically non-conductive surface. Unplug the Power Cord.**

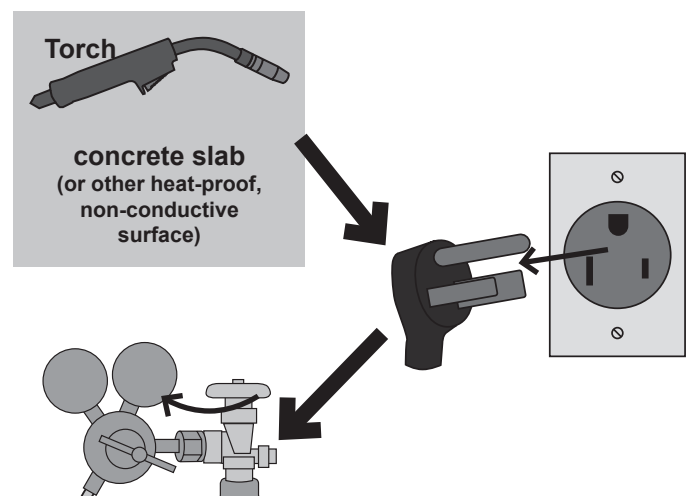

10. **MIG ONLY:**
Close shielding gas tank valve completely.

Welding Tips

A good way to test welding technique is to examine a weld's appearance after it has cooled and the slag has been removed. Then, better welding can be learned by adjusting your weld technique to remedy any problems found.

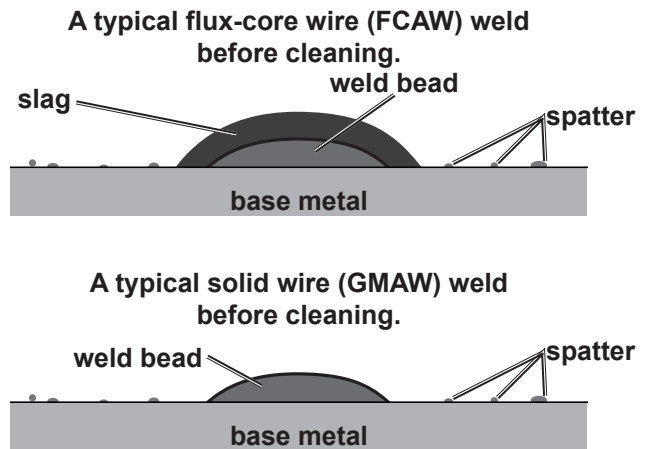

Cleaning the Weld

⚠️ WARNING



TO PREVENT SERIOUS INJURY: Continue to wear ANSI-approved safety goggles and protective wear when cleaning a weld. Sparks or chips may fly when cleaning.

1. A weld from flux core wire will be covered by slag, use the Chipping Hammer to knock this off. **Be careful not to damage the weld or base material.**
2. Then, use the Wire Brush to further clean the weld or use an angle grinder (sold separately) to shape the weld.

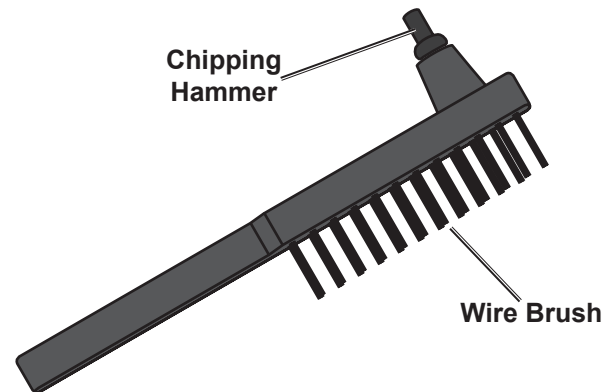

Strike Test

A test weld on a **PIECE OF SCRAP** can be tested by using the following procedure. **WEAR ANSI GOGGLES DURING THIS PROCEDURE.**

WARNING! This test **WILL** damage the weld it is performed on. This test is **ONLY** an indicator of weld technique and is not intended to test working welds.

1. After two scraps have been welded together and the weld has cooled, clamp one scrap in a sturdy vise.
2. Stay clear from underneath while you strike the opposite scrap with a heavy hammer, preferably a dead-blow hammer.
3. A **GOOD WELD** will deform but not break, as shown on top. A **POOR WELD** will be brittle and snap at the weld, as shown on bottom.

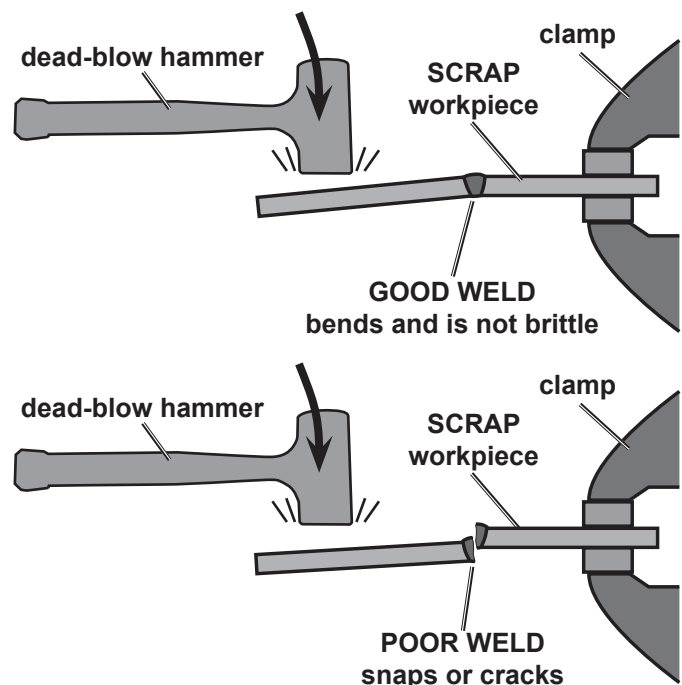

Workpiece Heat Control / Weld Penetration

SAFETY

SETUP

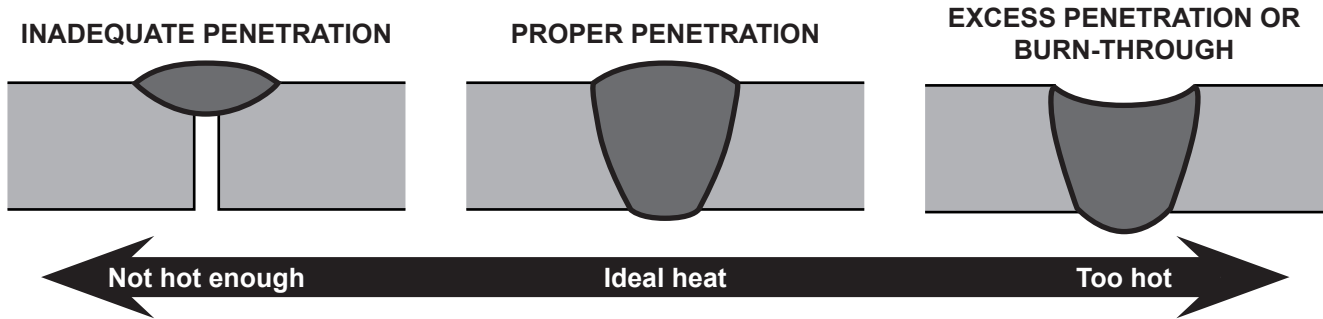

How to increase workpiece heat and increase penetration:
(to weld THICKER workpieces properly)

- a. Increase weld current
- b. Weld more slowly
- c. Use faster wire feed
- d. Use shorter stickout

How to reduce workpiece heat and limit penetration:
(to weld THINNER workpieces properly)

- a. Decrease weld current
- b. Weld more quickly
- c. Use slower wire feed
- d. Use longer stickout

Example Weld Diagrams

BASIC WELDING

WELDING TIPS

MAINTENANCE

Good Weld	Current Too Low or Wire Feed Too Slow	Current Too High or Wire Feed Too Fast	Weld Speed Too Fast	Weld Speed Too Slow	Stickout Too Long or Wrong Polarity
	TO CORRECT: Increase Current Min1 -> Min2 Min2 -> Max1 Max1 -> Max2 or 	TO CORRECT: Decrease Current Max2 -> Max1 Min1 -> Min2 or 	TO CORRECT: 	TO CORRECT: 	TO CORRECT: Check Polarity and maintain less than 1/2" stickout

Penetration (Workpiece Heat Control)

EXCESS PENETRATION OR BURN-THROUGH

Weld droops on top and underneath, or falls through entirely, making a hole.

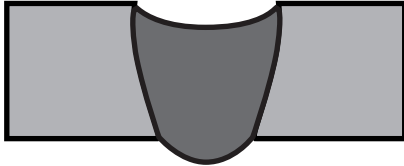

PROPER PENETRATION
Weld is visible underneath and bulges slightly on top.

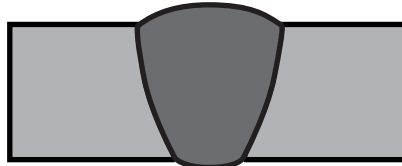

PROFILE VIEWS

INADEQUATE PENETRATION
Weld does not contact the joint fully, just on the surface.

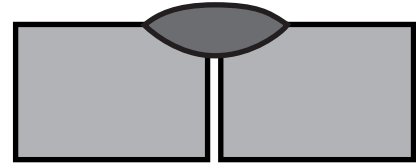

POSSIBLE CAUSES AND SOLUTIONS

- Workpiece overheating:**
Reduce wire feed speed.
Decrease weld current.
- Welding speed too slow:**
Increase welding speed and ensure that welding speed is kept steady.
- Excessive material at weld:**
Reduce wire feed speed.

POSSIBLE CAUSES AND SOLUTIONS

- Incorrect welding technique:**
Maintain 1/2" or less stickout.
Keep arc on leading edge of weld puddle.
Hold torch at proper angles.
- Insufficient weld heat:**
Reduce welding speed.
Increase weld current.
- Workpieces too thick/close:**
Bevel thick workpieces, allow slight gap, and weld in several passes.
- Insufficient weld material:**
Increase wire feed speed.

Bend at Joint

PROFILE VIEW

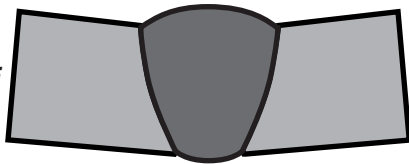

POSSIBLE CAUSES AND SOLUTIONS

- Improper clamping:**
Clamp workpieces securely.
Make tack welds to hold workpieces.
- Excessive heat:**
Weld a small portion and allow to cool before proceeding.
Increase weld speed.
Reduce wire feed speed.

Weld Not Adhering Properly

Gaps present between weld and previous bead or between weld and workpiece. See areas below.

PROFILE VIEW

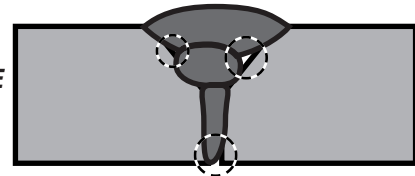

POSSIBLE CAUSES AND SOLUTIONS

- Incorrect welding technique:**
Place stringer bead at correct place in joint.
Adjust workpiece position or weld angle to permit proper welding to bottom of piece.
Pause briefly at sides during weave bead.
Keep arc on leading edge of weld puddle.
Hold torch at proper angles.
- Insufficient weld heat:**
Increase current.
Increase wire feed speed.
- Dirty workpiece:**
Clean workpiece down to bare metal.
- Insufficient weld material:**
Increase wire feed speed.

Coat of Slag Over Weld

TOP VIEW



PARTIALLY CHIPPED AWAY TO SHOW WELD

Slag is a necessary part of a flux-core wire weld. It shields the weld from impurities. Clean off the slag with the Chipping Hammer and Wire Brush after welding.

Gas-shielded MIG welds are protected by the shielding gas and do not need slag to protect them.

Porosity

Small cavities or holes in the bead.

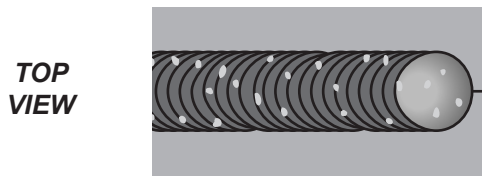

POSSIBLE CAUSES AND SOLUTIONS

1. **Incorrect polarity:**
Check that polarity is set correctly for type of welding.
2. **Insufficient shielding gas (MIG only):**
Increase flow of gas.
Clean nozzle.
Maintain proper stickout.
3. **Incorrect shielding gas (MIG only):**
Use shielding gas recommended by wire supplier.
4. **Dirty workpiece or welding wire:**
Clean workpiece down to bare metal.
Make certain that wire is clean and free from oil, coatings, and other residues.
5. **Inconsistent welding speed:**
Maintain steady weld speed.
6. **Stickout too long:**
Reduce stickout.

Excessive Spatter

Fine spatter is normal.
Spatter that is grainy and large is a problem.

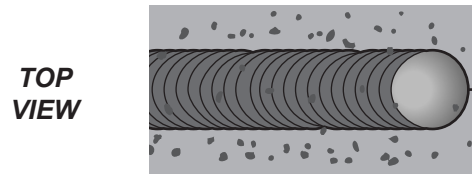

POSSIBLE CAUSES AND SOLUTIONS

1. **Dirty workpiece or welding wire:**
Clean workpiece down to bare metal.
Make certain that wire is clean and free from oil, coatings, and other residues.
2. **Incorrect polarity:**
Check that polarity is set correctly for type of welding.
3. **Insufficient shielding gas (MIG only):**
Increase flow of gas.
Clean nozzle.
Maintain proper stickout.
4. **Wire feeding too fast:**
Reduce wire feed speed.
5. **Stickout too long:**
Reduce stickout.

Crooked/Wavy Bead

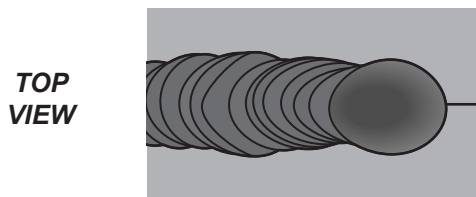

POSSIBLE CAUSES AND SOLUTIONS

1. **Inaccurate welding:**
Use two hands or rest hand on steady surface.
2. **Inconsistent welding speed:**
Maintain steady weld speed.
3. **Stickout too long:**
Reduce stickout.

Burn-Through

Base material melts away,
leaving a hole in the weld.

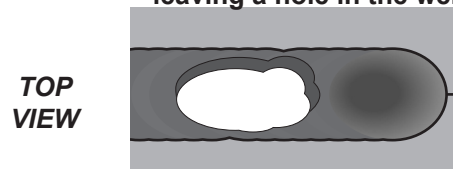

POSSIBLE CAUSES AND SOLUTIONS

1. **Workpiece overheating:**
Reduce current and/or wire feed speed.
2. **Welding speed too slow:**
Increase welding speed and ensure that welding speed is kept steady.
3. **Excessive material at weld:**
Reduce wire feed speed.

⚠ WARNING



TO PREVENT SERIOUS INJURY, FIRE AND BURNS:
Unplug the welder, rest the Torch on a heat-proof, electrically non-conductive surface, and allow all parts of the Welder to cool thoroughly before service.

1. Periodically remove the Side Panel, and using compressed air, blow out all dust from the interior.
2. Store in a clean and dry location.
3. **For optimal weld quality, clean and inspect the Contact Tip and Nozzle before each use, as explained below:**

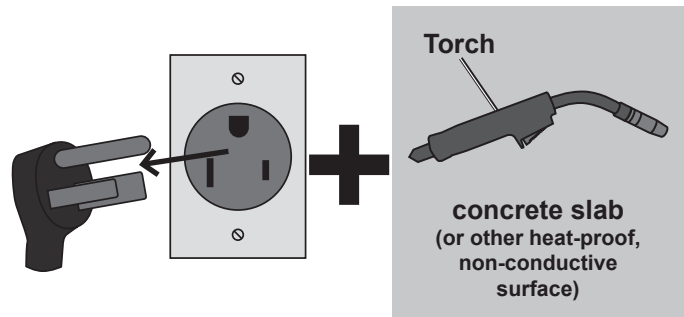

Nozzle and Contact Tip Inspection and Cleaning

1. **Make sure that the entire Torch is completely cool and that the Power Cord is unplugged from the electrical outlet before proceeding.**
2. Turn the Nozzle counterclockwise while pulling to remove.
3. Scrub the interior of the Nozzle clean with a wire brush.
4. Examine the end of the Nozzle. The end should be flat and even. If the end is uneven, chipped, melted, cracked, or otherwise damaged, the Nozzle will adversely effect the weld and should be replaced.
5. Using the third oval hole on the Multi-wrench, turn the Contact Tip counterclockwise and slide it off the welding wire.
6. Scrub the outside of the Tip clean with a wire brush. Clean out the inside of the tip with a tip cleaner (sold separately). Check that the Tip is the proper type for the wire size used.
7. Examine the shape of the hole at the end of the Contact Tip. It should be an even circle, it should not be oblong or have any bulges in it.
8. If any problems are noted, Contact Tip replacement would be advisable. Select a new Tip that is the correct size for the welding wire used.
9. Reinstall the Tip and securely reinstall the Nozzle as well.

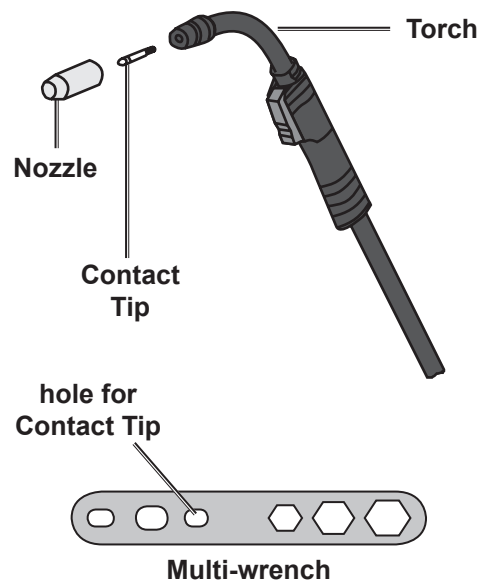

Troubleshooting

IMPORTANT!

Be **CERTAIN** to shut off the Welder, disconnect it from power, and discharge the Torch to ground before adjusting, cleaning, or repairing the unit.

SAFETY

Wire feed motor runs but wire does not feed properly

POSSIBLE CAUSES AND SOLUTIONS

1. **Insufficient wire feed pressure:**
Increase wire feed pressure properly - follow step 17 on page 17.
2. **Incorrect wire feed roll size:**
Flip roll to correct size, follow the *Wire Spool Installation* instructions, starting on page 12.
3. **Damaged Torch, cable, or liner assembly:**
Have a qualified technician inspect these parts and replace as necessary.

SETUP

Wire creates a bird's nest during operation

POSSIBLE CAUSES AND SOLUTIONS

1. **Excess wire feed pressure:**
Adjust wire feed pressure properly - follow step 17 on page 17.
2. **Incorrect contact tip size:**
Replace with the proper tip for wire used.
3. **Torch end not inserted into drive housing properly:**
Loosen torch securing bolt and push torch end into housing just enough so that it does not touch wire feed mechanism.
4. **Damaged liner:**
Have a qualified technician inspect and repair/replace as necessary.

BASIC WELDING

Welding arc not stable

POSSIBLE CAUSES AND SOLUTIONS

1. **Wire not feeding properly:**
See first *Troubleshooting* section above.
2. **Incorrect contact tip size:**
Replace with the proper tip for wire used.
3. **Incorrect wire feed speed:**
Adjust wire feed speed to achieve a more stable arc.
4. **Loose Torch cable or ground cable:**
Check to ensure that all connections are tight.
5. **Damaged Torch or loose connection within Torch:**
Have a qualified technician inspect and repair/replace as necessary.

WELDING TIPS

Weak Arc strength

POSSIBLE CAUSES AND SOLUTIONS

1. **Incorrect line voltage:**
Check the line voltage and, if insufficient, have a licensed electrician remedy the situation.
2. **Improper gauge or length of cord:**
Extension cords are not recommended. If possible, eliminate the use of an extension cord. If a longer cord is needed, refer to the replacement cord guidelines on page 7.
3. **Not enough current:**
Switch current to proper setting for metal thickness.

MAINTENANCE

Troubleshooting (continued)

IMPORTANT!

Be **CERTAIN** to shut off the Welder, disconnect it from power, and discharge the Torch to ground before adjusting, cleaning, or repairing the unit.

Power switch lights, but welder does not function when switched on

POSSIBLE CAUSES AND SOLUTIONS

1. **Tripped thermal protection device:**
Stop welding and allow welder to cool for at least 20 minutes.
Reduce duration or frequency of welding periods to help reduce wear on the welder.
Refer to **Duty Cycle** section on page 20.
2. **Faulty or improperly connected Trigger:**
Qualified technician must check and secure/replace Trigger.

Power switch does not light when switched on

POSSIBLE CAUSES AND SOLUTIONS

Unit is not connected to outlet properly or outlet is unpowered:

Verify the voltage at the outlet and the connection to the outlet.

If voltage is not present at outlet, check circuit breaker/GFCI devices; if any are tripped, determine and remedy cause before resetting.

Verify that the circuit is designed to supply the required input voltage and amperage as detailed on the **Specifications** table.

Make sure installed plug is correct rating (250 V~, 50 A recommended) - see page 7.

Wire Feeds, but arc does not ignite

POSSIBLE CAUSES AND SOLUTIONS

1. **Improper ground connection:**
Make certain that the workpiece is contacted properly by the Ground Clamp and that the workpiece is properly cleaned near the ground clamp and the welding location.
2. **Improperly sized or excessively worn Contact Tip:**
Verify that Contact Tip is the proper size for welding wire.
Check that the hole in the tip is not deformed or enlarged.
Also, check that the tip is not dirty; this would prevent a good connection.
If needed, replace Contact Tip with proper size and type.

PLEASE READ THE FOLLOWING CAREFULLY

THE MANUFACTURER AND/OR DISTRIBUTOR HAS PROVIDED THE PARTS LIST AND ASSEMBLY DIAGRAM IN THIS MANUAL AS A REFERENCE TOOL ONLY. NEITHER THE MANUFACTURER OR DISTRIBUTOR MAKES ANY REPRESENTATION OR WARRANTY OF ANY KIND TO THE BUYER THAT HE OR SHE IS QUALIFIED TO MAKE ANY REPAIRS TO THE PRODUCT, OR THAT HE OR SHE IS QUALIFIED TO REPLACE ANY PARTS OF THE PRODUCT. IN FACT, THE MANUFACTURER AND/OR DISTRIBUTOR EXPRESSLY STATES THAT ALL REPAIRS AND PARTS REPLACEMENTS SHOULD BE UNDERTAKEN BY CERTIFIED AND LICENSED TECHNICIANS, AND NOT BY THE BUYER. THE BUYER ASSUMES ALL RISK AND LIABILITY ARISING OUT OF HIS OR HER REPAIRS TO THE ORIGINAL PRODUCT OR REPLACEMENT PARTS THERETO, OR ARISING OUT OF HIS OR HER INSTALLATION OF REPLACEMENT PARTS THERETO.

Wiring Diagram

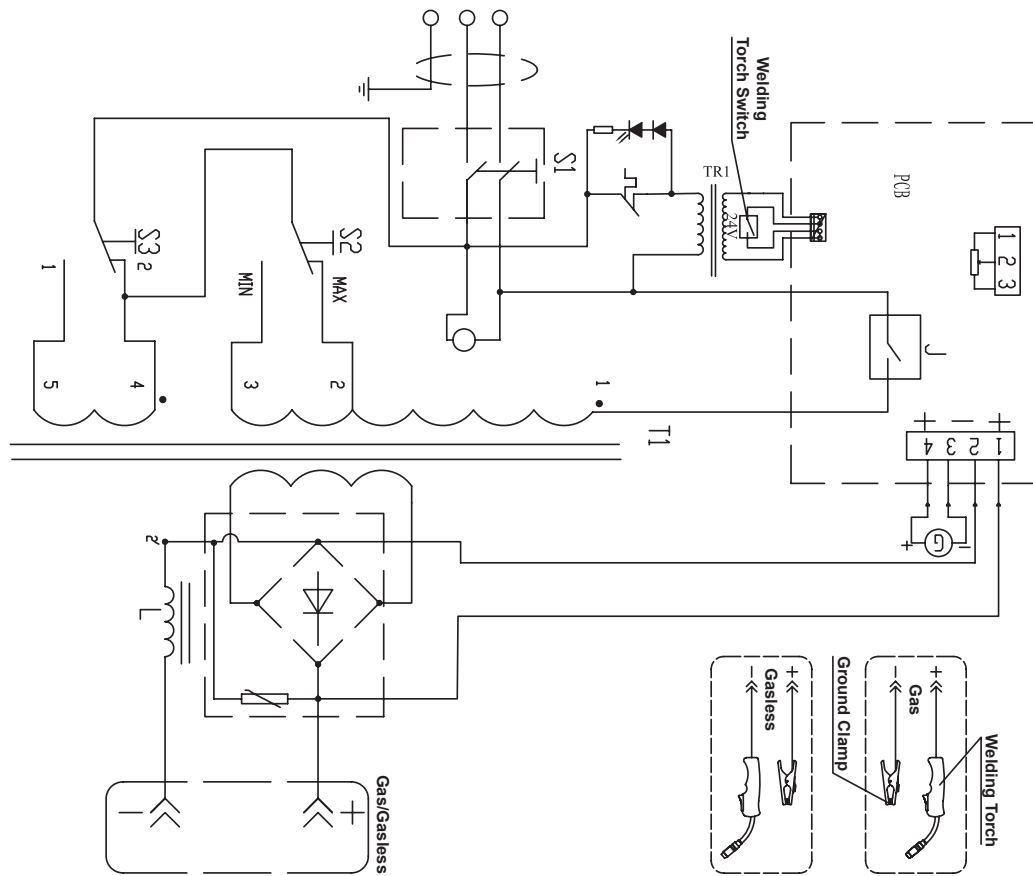

Parts List

Part	Description	Qty
1	Ground Clamp (and Cable)	1
2	Power Cord	1
3	Grommet	2
4	Current Switch	2
5	Wire Speed Knob	1
6	Front Panel	1
7	PCB Holder	1
8	PCB	1
9	Divider	1
10	Control Transformer	1
11	Thermal Protector	1
12	Transformer	1
13	Foot	4
14	Right Panel	1
15	Gas Connector	1
16	Back Panel	1
17	Rectifier Bracket	1
18	Fan	1
19	Rectifier	1

Part	Description	Qty
20	Handle	1
21	Spool Holder	1
22	Hinge	2
23	Wire Feed Mechanism	1
24	Left Panel	1
25	Red Terminal	1
26	Latch	1
27	Black Terminal	1
28	Rubber Tube	1
29	Indicator	1
30	Torch Cable Grommet	1
31	Power Switch	1
32	Torch (and Cable)	1
33	Face Shield Handle	1
34	Face Shield Shell	1
35	Filter Lens	1
36	Wire Brush / Chipping Hammer	1
37	Wrench	1

Record Serial Number Here: _____

Note: If product has no serial number, record month and year of purchase instead.

Note: Some parts are listed and shown for illustration purposes only, and are not available individually as replacement parts.

Assembly Diagram

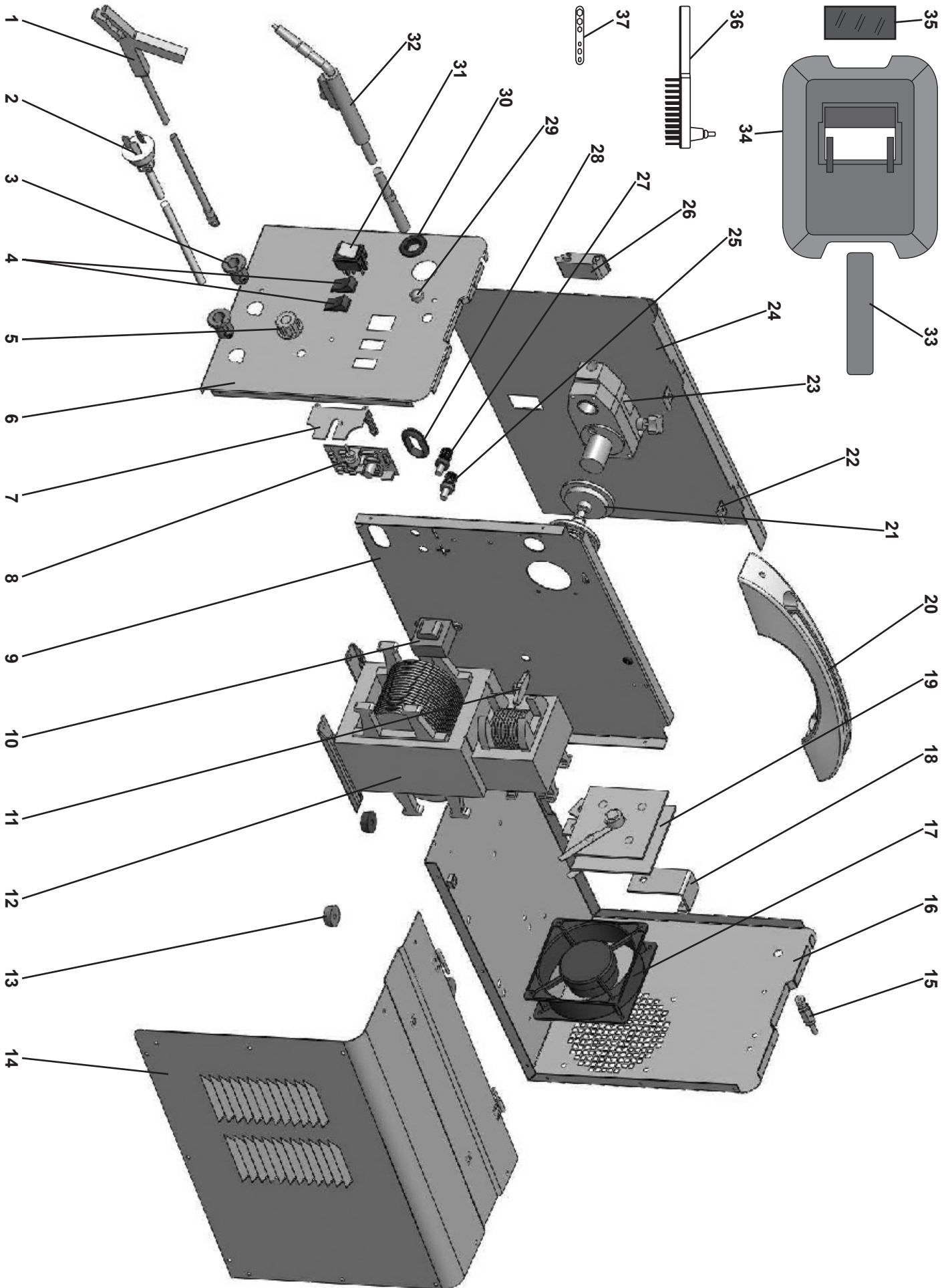

SAFETY

SETUP

BASIC OPERATION

SPILL OPERATION

MAINTENANCE

Limited 90 Day Warranty

Harbor Freight Tools Co. makes every effort to assure that its products meet high quality and durability standards, and warrants to the original purchaser that this product is free from defects in materials and workmanship for the period of 90 days from the date of purchase. This warranty does not apply to damage due directly or indirectly, to misuse, abuse, negligence or accidents, repairs or alterations outside our facilities, criminal activity, improper installation, normal wear and tear, or to lack of maintenance. We shall in no event be liable for death, injuries to persons or property, or for incidental, contingent, special or consequential damages arising from the use of our product. Some states do not allow the exclusion or limitation of incidental or consequential damages, so the above limitation of exclusion may not apply to you. THIS WARRANTY IS EXPRESSLY IN LIEU OF ALL OTHER WARRANTIES, EXPRESS OR IMPLIED, INCLUDING THE WARRANTIES OF MERCHANTABILITY AND FITNESS.

To take advantage of this warranty, the product or part must be returned to us with transportation charges prepaid. Proof of purchase date and an explanation of the complaint must accompany the merchandise. If our inspection verifies the defect, we will either repair or replace the product at our election or we may elect to refund the purchase price if we cannot readily and quickly provide you with a replacement. We will return repaired products at our expense, but if we determine there is no defect, or that the defect resulted from causes not within the scope of our warranty, then you must bear the cost of returning the product.

This warranty gives you specific legal rights and you may also have other rights which vary from state to state.



3491 Mission Oaks Blvd. • PO Box 6009 • Camarillo, CA 93011 • (800) 444-3353